

CS448 Isolated Channel Oscilloscope Specification

Summary

The CS448 is an individually isolated channel high CMRR oscilloscope with four channels. It is designed to measure all the signals in an operating full or three phase power electronic switching bridge. Examples include gate drives to measure voltage and charge, the power switch to measure loss and parasitic stress, the output to measure power and spectrum for EMC compliance, and the control system for Gain/Phase and stability. The CS448 includes an isolated signal generator for stimulus, and eight digital inputs to measure control signals. Two CS448's can be slaved to make an 8 channel oscilloscope with coherent sampling. See the selected measurements at the end of the specification section for visual examples of measurements made.

Front



Calibration

- Probe Comp output ~ 1ns rise-time, programmable 8-12V level.
- Programmable Cal Ref for complete probe and channel DC calibration. Ref is 7.5V or 0.6818V ± 0.03%, or short to ground.

Chan A - Chan D inputs:

- 2kV operating isolation voltage to ground and other channels (Cat II).
- 1 kV Cat III rating.
- 100 dB CMRR at 50 MHz
- 14 bit resolution, 100dB dynamic range
- 200 MHz BW
- 14 pF to chassis
- 100uV resolution on 0.8v range
- 200uV rms noise on 0.8V range
- probe isolators for protection.

IN 1-8 Digital inputs:

- Isolated 1kV working (2 separate pods of 4 channels with a common)
- 400/500 Mbps
- 5 pF to chassis
- 100 kV/us transient immunity
- Logic level threshold voltage.

Back



Signal Generator:

- Isolated 600V working
- 0 - 65 MHz
- 14 pF to chassis
- 100 dB CMRR at 50 MHz
- Sine, square, arbitrary (incl patterns)* 100uV rms noise

Digital Port:

- 16 bi-directional pins connected to Silego SLG46533V analog/digital programmable device*
- Trigger In/Out connection*

Link Port:

- Links to CS1070 0-50 MHz 1A power amplifier, CS1110 VCE Sat probe.
- Includes Uart, SPI and I2C I/O*
- Trigger and control *

SD Card:

- Store stand-alone captures to the SD Card *

USB:

- USB 3-C socket
- USB3 @ 130MBps
- USB2 @ 30 MBps

Ethernet: *

- SFP socket based
- Copper 10/100/ 1000 Mbps
- Fibre 1Gbps

Link In/Out:

- Used to daisy chain multiple units
- Synchronous sample clock
- Trigger and control

Power In:

- 10- 24V DC, 36W.
- Can be car power supply connected, withstands crank and load dump.

Triggering

- Two FPGA mixed signal triggers
- Triggers interpolate in time for higher trigger accuracy.
- Triggers may be combined using AND/OR/XOR
- Triggers may be sequences Trigger 1 [num occurrences] - time specification - Trigger 2 [num occurrences] . The time specification is less than a period, in a period range or more than a period. Triggers may be completely independent.
- The digital portion may be rising or falling digital input, conditional on one or more other digital inputs being 0, 1 or don't care. Bit's may be OR'd or AND'd.
- The analog trigger may be conditional on a digital state.

* Item still to be implemented. See Specification Status section.

Analog Inputs

* Item still to be implemented. See Specification Status section.

Parameter	Specification	Notes
Number of channels	4	Fibre optic isolated from each other
Isolation Voltage	1kV working Cat III, 2kV Cat II, when connected to mains systems of less than 300V line-neutral	Supported by IEC 61010-1 Ed 3.0 and IEC 61010-2-30 (Test Equipment) 20mm creepage and 16 mm clearance, reinforced, Category III Plan to certify
CMRR	> 120 dB at 1 MHz > 115 dB at 10 MHz > 100 dB at 50 MHz	20dBV signal applied to coax common and earth reference 4mm socket.
ADC resolution	14 bits	
Input Ranges	$\pm 0.8V$ and $\pm 8V$	Use probes to extend the range, eg 800V with 100x probe. The application automatically scales all values to compensate for probe attenuation.
Sample Rate	500 MSPS * 400 MSPS now	All Analog and Digital channels simultaneously.
Sample Memory	500 M Samples * (installed)	Currently 4 x simultaneous channels with 10M per channel.
CM leakage to other channels	<-125dBc	20 dBV signal to CM channel, measured on other channels whole bandwidth, $\pm 0.8V$ range
Channel to Channel Skew	< $\pm 144ps$	Done using a 1 MHz coherent sine wave
Cross talk at 10.7 and 30 MHz	< -115 dBc	Using 1.6V p-p into the channel
RMS Channel Noise 1 M samples	~ 200 μV rms, $\pm 0.8V$ range ~ 2mv rms, $\pm 8V$ range	Inputs open
Pk-Pk Channel noise 1 M samples	1.8mVp-p for $\pm 0.8V$ range 15mVp-p for $\pm 8V$ range	Inputs open
Sample clock jitter	300 fs rms	
Sample clock Freq tolerance	max $\pm 2ppm$	At 25 deg C
Sample clock temp stability	max $\pm 0.5 ppm$	Over -40 to +85 deg C
Enob (rms)	11.6 bits, or 1 part in 3,300	Inputs open
Noise free bits	10.3 bits, or 1 part in 1300	Inputs open
Spectral Noise floor, no protrusions	-100 dBV -115dBV	<2MHz, 200 MHz BW, 1kHz resolution >2MHz, 200 MHz BW, 1kHz resolution
Sinad	> 64 dBc at 1 MHz > 63 dBc at 10 MHz > 55 dBc at 30 MHz	1 Vp-p into 50 ohms signal
HD2+3	< -80dB at 1MHz < -76 dB at 10 MHz < -71 dB at 30 MHz	1 Vp-p into 50 ohms signal
THD	< -76 dB at 1 MHz < -74 dB at 10 MHz < -67 dB at 30 MHz	1 Vp-p into 50 ohms signal
Pulse Flatness	< 700uV < 2mV < 200mV	0.5V pulse, 500us duration, $\pm 0.8V$ range 0.5V pulse, 500 us duration, $\pm 8V$ range 500V pulse, 500us duration, 100x probe
Overload recovery	4ns	Recovery from 10x overload
Maximum Differential Input Voltage	$\pm 1 kV$, derated above 1 MHz.	Derated at 20dB/decade
Maximum Common Mode Input Voltage	$\pm 2 kV$, derated above 10 MHz.	Derated at 20dB/decade
Spectral Flatness	$\pm 0.5dB$ from 0 - 160 MHz -3 dB at 200 MHz	Supports 200 MHz Bandwidth
Input Resistance	1 M Ohm	DC resistance
Input Capacitance	20 pF	Signal Input to Signal Common
Isolation Capacitance	< 14pF	Channel ground to chassis

Channel to Channel Isolation

The CS448 digitizer is held in a plastic insulator tray to maximize creepage and clearance. The tray has a CTI>600.

Each Channel PCB is completely separate and attached to the digitizer board using a spacer. The plastic spacers and transformer formers (CTI >600) provide a creepage and clearance > 20mm. The transformers use triple insulated wire Rubadue wire (T32A01T5XX-1.5). The Fibre Optic link has a breakdown voltage >30kV.

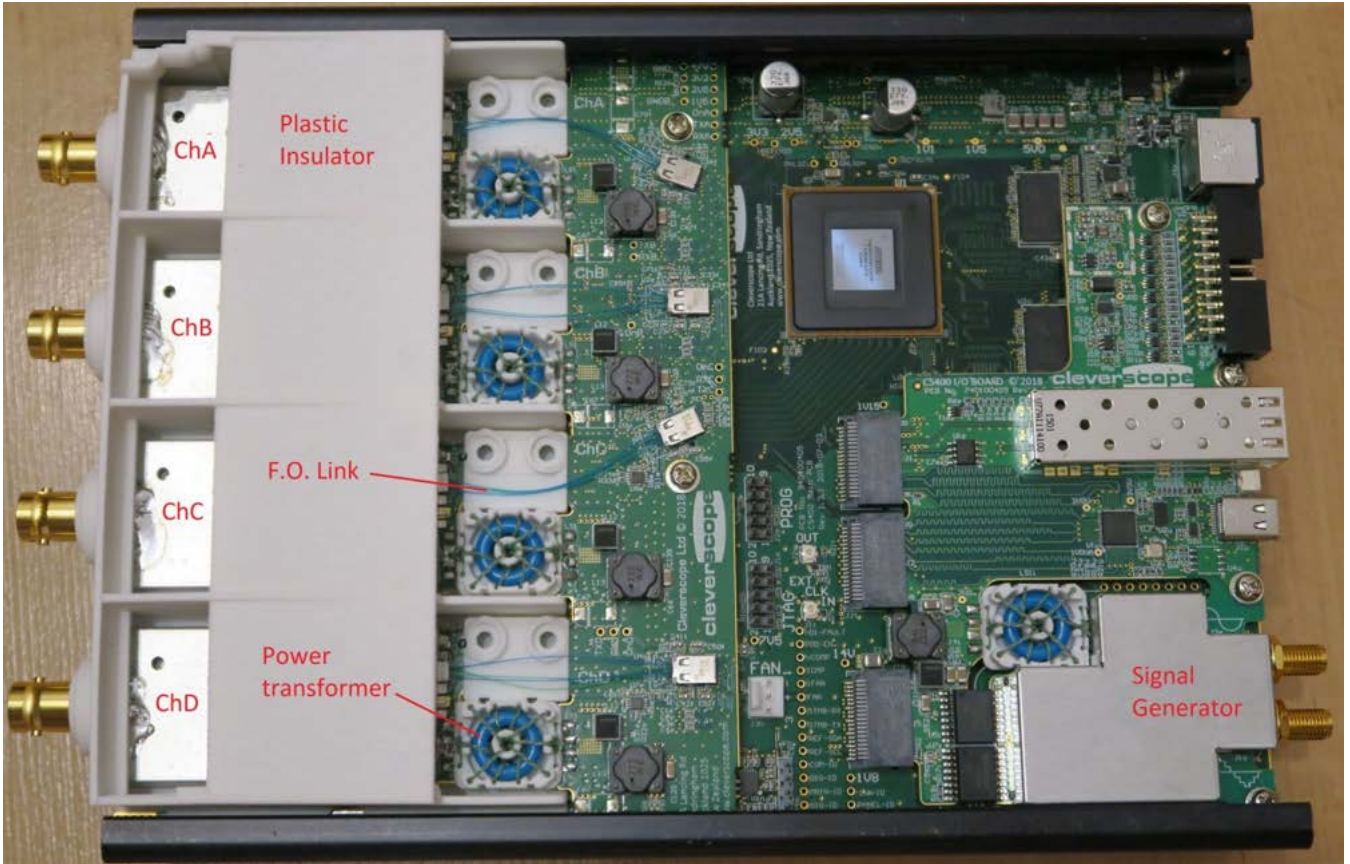

In this view (using a grey plastic insulating tray) we have omitted a transformer to show the separation.

Parameter	Specification	Notes
	<p>Minimum creepage = 20 mm</p> <p>Minimum Clearance = 16 mm (from shield to upper enclosure surface)</p>	<p>IEC61010-2-030 Ed 1.0 (Test Equipment), Table K.13. 1000VAC, requires >10mm for reinforced, Materials group 1, II, III, pollution degree 2</p> <p>IEC61010-2-030 Ed 1.0 (Test Equipment), Table K.101. 1000V, Measurement Category III, mains circuits up to 300V line to neutral requires >5.9 mm reinforced.</p>

Digital Inputs

Parameter	Specification	Notes
Number of inputs	8	
Common mode transient immunity	100 kV/us	
Input threshold max	2.3V rising 0.9V falling	Using CS1006/7 isolated probes (ISOW7844). Using CS1004/5 probes, threshold programmable 0-8V.
Isolation capacitance	< 5pF	To chassis ground, at 1 MHz
Isolation operating voltage	880V DC 1130V DC	Re-inforced insulation, EN61010-1 Re-inforced insulation, CSA and IEC 60950-1
Maximum Data rate	100 Mbps	Sampled at 500 MSPS* (400 MSPS now).
Propagation delay	13ns typ	Compensated for within CS448



Signal Generator

Parameter	Specification	Notes
Output Frequency Range	DC - 65 MHz	-3dB at 65MHz on un filtered output
Outputs	Unfiltered, filtered	Unfiltered is used high slew rate signals (AWB or square wave). Filtered includes a reconstruction filter for minimum sample clock injection into the signal.
CMRR	> 100 dB at 1 MHz > 95 dB at 10 MHz > 90 dB at 50 MHz	Limited by analog channels used for test. The Sig Gen connection reduces CMRR by about 20 dB, if direct connected to a Channel.
Common mode transient immunity	100 kV/us	For control of the output DAC
Isolation Voltage	800 VRMS working	Supported by IEC 61010-1 creepage and clearance, reinforced, Category III Plan to certify
Unfiltered rise/fall time	3.2ns	Full scale swing
Sine Wave Flatness	±0.2 dB +0.2 -3 dB	0 - 30 MHz filtered + unfiltered 30 - 65 MHz unfiltered
DAC resolution	12 bits	
NCO Resolution	24 bits	10.7 Hz resolution at 180 MSPS
Output amplitude	±1mV to ±3.5V p-p	Programmable 1mV resolution, constrained to total range ±3.5V including offset
Output offset	0 to ±3.5V p-p	Programmable, 1mV resolution
Output Noise	< 100uV rms	
SFDR	> 84 dBc	At 10 MHz
IMD	> 88 dBc	At 10 MHz
HD2+3	< -77dBc	At 10 MHz
Arb Waveform Memory	4 k Samples *	Using AD9102 - UI to be implemented still
Sample Rate	180 Msps	Programmable Sample rate 1sps - 180 Msps
Frequency list values	2k *	Frequency list output in response to trigger
Envelope can be amplitude modulated	Yes *	
Pattern Generator	Yes *	Start period, output period, stop period, pattern repeat count.
Trigger	Input from FPGA *	FPGA may trigger a pattern based on Channel Trigger or other event.

USB

Parameter	Specification	Notes
Supported Modes	USB 2.0 and USB 3.0	USB 2.0 @480 Mbit/sec and USB 3.0 at 5 Gbps
Throughput	30 MBps and 130 MBps	
Connector	USB-C	Plug is reversible
Protection	Common mode choke + ESD diodes	Using ECMF04-4HSWM10
Indicators	USB on and correctly connected	Loss of signal is indicated by LED off.

Ethernet *

Parameter	Specification	Notes
Connection method	Small Form factor Pluggable module (SFP)	An SFP socket is provided for use with an SFP module. Either an optical or a copper connected SFP module will be supplied based on the order.
Wired Supported Modes	Ethernet 10/100/1000 *	Using an RJ45 Ethernet socket connected copper SFP module. Transformer based isolation.  Software being implemented
Optical supported mode	Ethernet 1000BASE-LX *	Gigabit (1G) Ethernet using an LC fibre cable connected optical module. Full optical isolation.  Software being implemented
Throughput	12 MBps and 120 MBps	
Connector	SFP Socket	Small Form Factor Pluggable socket
Indicators	Ethernet on and correctly connected	Loss of signal is indicated by LED off.

Power Supply

Parameter	Specification	Notes
Input Voltage Range	10-24 DC	
Power consumption	36W	
Connector	Barrel Socket, 2.5mm I.D. x 5.5mm O.D	Connection is reverse polarity protected.
Protection	Clamped to +68V Clamped to -32V Operates with 35V Survives with 5V	ISO16750 pulse A (79 ohm 0.5 ohm) ISO7637 Pulse 1 (-600V, 50 ohm) FPGA operation at 5V, ADC operational at 7V.
Indicators	Power On	Software controlled.

Digital Port *

The Digital Port is based on a programmable logic IC, and can be used for generating complex state based sequences or reacting to a complex set of inputs. The port includes triggering capability. The UI has not been completed.

Parameter	Specification	Notes
Input/Outputs	16	Programmable as In or Out
Logic Level	Programmable 1.8 - 5V	All I/O operate at the same logic level
Control IC	Silego SLG46533V	User configurable programmable logic with analog functions
Resources	24 Look Up Tables (LUTs) Prog Oscillator, 25MHz, 2MHz, and 25 kHz. Prog Delay, 3 Output 16x8 RAM and OTP 4 Analog Comparators 2 x Deglitch filters	2-4 bit for complex logic All resources can be arbitrarily connected as required.
Programming	Silego GP Designer	Visual schematic designer of circuit functions downloaded into CS448
Trigger In/Out	Bidirectional Trigger	The trigger may be programmed to initiate a Digital Port sequence, or the Digital Port can trigger an analog acquisition.
Protection		Over voltage protection to +12V and -6V

Link Port *

The Link Port is used for controlling Cleverscope accessory devices such as the CS1070 1A 50 MHz power amplifier, and the CS1110 V_{CE} Sat Probe. It also includes RS232, SPI and I²C ports for controlling user equipment.

Parameter	Specification	Notes
Digital Port Use	2 Digital In, 4 Digital Out	Used for accessory control
I2C Port	400 pbps port	For control of user devices
SPI Port	1 MHz SPI Port	For control of user device, mutually exclusive with RS232 Port
RS232/RS422 Port	3V level RS232 port, or differential RS422 port, programmable baud rate	For control of user device, mutually exclusive with SPI Port
Trigger Port	Trigger In/Out and control	Used for linkage to CS328A link port
Protection		Over voltage and reverse voltage protection using ESD devices

Link In/Out Port

The Link In/Out Port is used daisy chaining 2 or more CS448 Cleverscopes.

Parameter	Specification	Notes
Clock ports	Reference clock, 500 kHz	The last CS448 in the chain provides the 500 kHz reference clock that is used for simultaneous sampling by all units.
Trigger Ports	Trigger transfer	The Trigger Ports transfer the triggering unit's trigger to other units.
Control Ports	Control signals	The control signals are used to signal readiness to trigger, and sampling state.

See the selected measurements section for an example 8 channel display.

Probe Compensator Output

The probe Compensator output is used to compensate the probe response for time domain flatness.

Parameter	Specification	Notes
Signal	1 kHz Square Wave	Variable 50mHz to 58.3 Mhz
Duty Cycle	50%	Variable with 8.6ns resolution.
Amplitude	Programmable 5-12V	
Rise Time	~ 1ns	
Connection	BNC, 50 Ohm source	Designed for 10x probe. Cannot drive 50 Ohm load.

Environmental

Parameter	Specification	Notes
Temperature	0°C to +40°C -20°C to +60°C	Operating Storage
Cooling Method	Fan Assisted	
Humidity	0°C to +40°C >40°C	<90% relative humidity <60% relative humidity
Altitude	<3,000m 15,000m	Operating Non-operating

Mechanical

Parameter	Specification	Notes
Size	Height 55 mm Width 164 mm Length 247 mm	Including feet Including connectors
Weight (approx)	1150 gm 2400 gm	Acquisition Unit only Complete in display box
Material	Powder Coated Aluminium	

Specification Status

The CS448 is FPGA based, and upgradeable in the field. The customer can use Cleverscope Rom Loader too download new firmware and logicware to improve or add functions to the unit. The hardware system for the CS448 has been thoroughly tested to meet the specifications above, and includes all the resources needed to meet the full specification. However some software functions are still to be added. As these are added, updates are placed on our website for download at no cost. Cleverscope has used this method for years to add features such as FRA, streaming, complex maths etc. Should the current specification set meet your needs, you are able to use the CS448 now, and upgrade, at no cost, as further functionality becomes available.

Key features that still have to be implemented are:

Feature	Specification	Note
Sampling Rate	500 MSPS	Currently the sample rate is 400 MSPS. It will be upgraded to 500 MSPS on the completion of the Ethernet system.
I/O Interfaces	Ethernet is supported	Ethernet is currently not supported. We have implemented a hardware based IP stack, which is functional. Integration is proceeding with the CS448 firmware.
Sample Memory	250 MSamples.	Physical memory for 500 MSamples (16 bit) is provided. Currently we use only 40 MSamples of it organized as 4 fixed simultaneous buffers of 10MSamples - one for each channel. We will provide options of 500 MSamples/1 channel, 250 MSamples/2 channels and 125 Msamples/4 channels in the future once the application allows.
Two unit Linking	Two unit linking via Link In and Link Out Ports	Two units linking is functional. An example is given in the selected measurements. We do intend to allow up to 4 units to link, but some work still needs to be done for this.
Signal Generator Waveforms	The signal generator will support AWB	The isolated Signal Generator currently only supports Sine and variable duty cycle Square wave generation and sweeping. The hardware (based on the AD9102) can generate 4K Arbitrary Waveforms, and patterns. The sig gen design includes a swept clock source to allow sweeping arbitrary waveforms (including square and triangle waves). The user interface for this is not yet done.
Link Port	The Link includes SPI, UART and I2C generation	The Link Port includes the facilities to generate I2C, Uart and SPI messages, as well as digital outputs. This capability is already supported by the firmware and DLL driver. However a UI has not been implemented in the application. This will be done as time permits.
Real time Sample Filtering	Real Time sample filters to improve dynamic rang	The filter block for the programmable FIR filter has been implemented, but is operating with a fixed coefficient set. The firmware to load a variable coefficient set still need to be implemented.
Faster Peak Capture	Replay Peak Capture to run at close to real time	The current system has real time peak capture where the decimator outputs samples at below the maximum sample rate (eg Streaming). However, the replay peak capture system, while working, is not optimized and relatively slow. A DMA/Hardware based system will be used for peak capture replay.
Digital Port	Full use of Silego SLG46533V	Hardware has been tested. The Silego programmer can be used. The CS448 will provide Silego design download at some point.

Where a feature has not been implemented yet, it includes an asterisk in the table above.

Selected Measurements

In this section we show some of the measurements that define the unique aspects of the CS448.

Common Mode Rejection

Channel A is being tested for CMRR using a 20 dBV source, and ranges from -120dB to -107dB. The scale is in dB CMRR.

Channels B, C and D show the dBV response to the Chan A common mode signal, and the response is in dBV. As the excitation used is +20 dBV, the leak through is about -125 dBc.

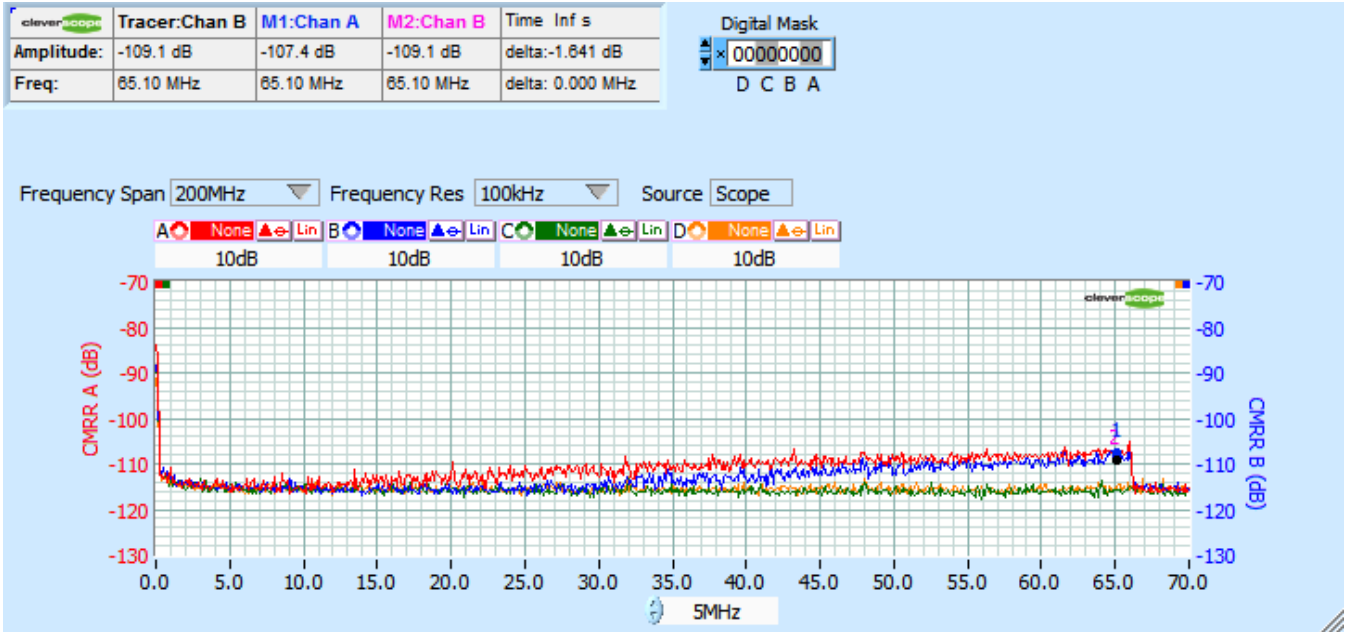

Application in switching Power Bridge

Using this full bridge setup, which swings 500V in 8ns:

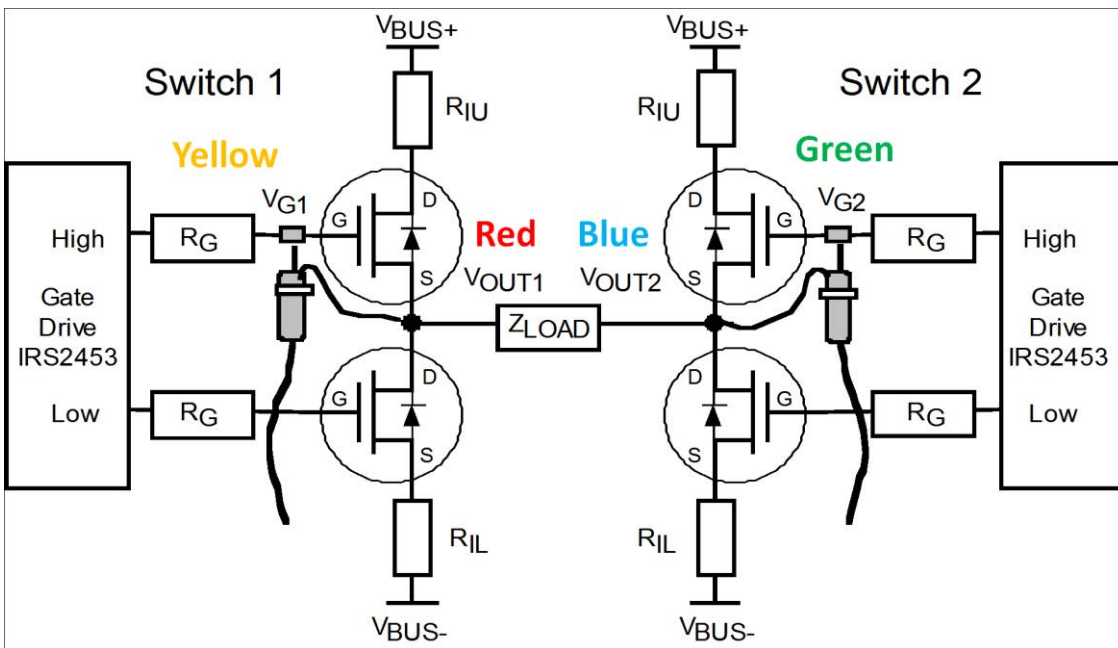

We measure these results:

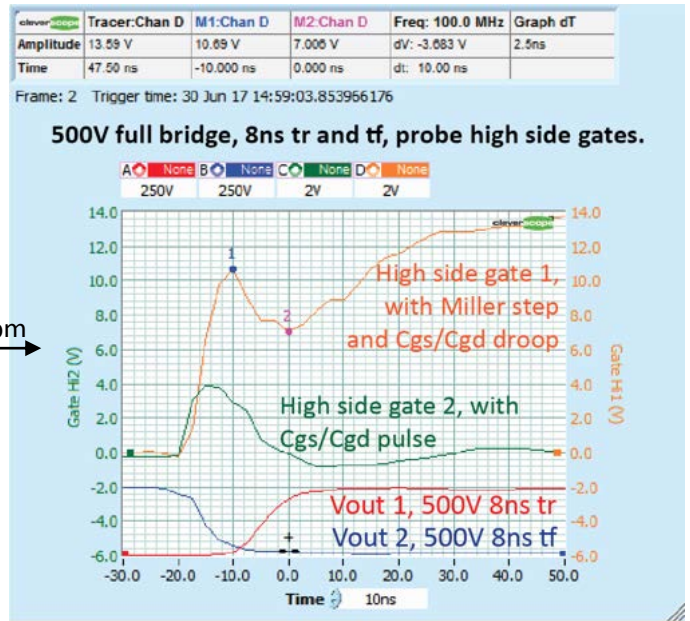
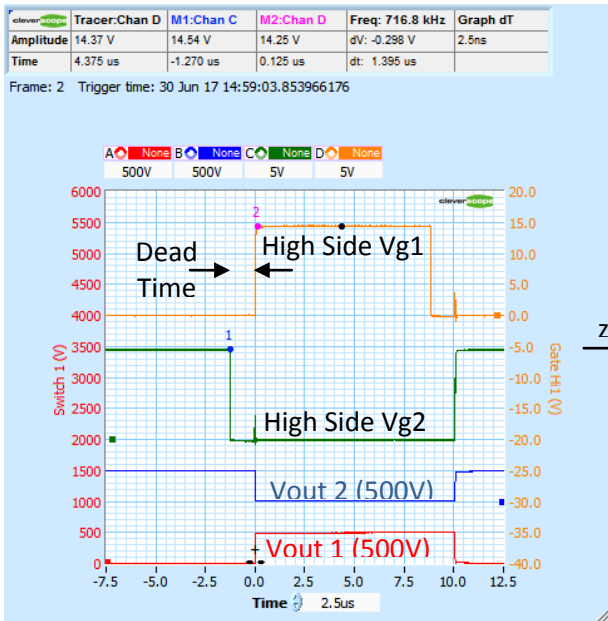

The high CMRR, and the isolation allow the high side gate drives to be measured without large common mode artifacts. We can observe dead time, pulse timing, the gate charge characteristic, and parasitics such as the Cgs/Cgd droop and pulse effects.

Measurements on a full bridge with 8 channels

Two units can be slaved together using the Link Out port connected to the Link In port with the CS1021 500mm link cable. Here are four gates, two gate drives, and two Switch nodes on the full bridge:

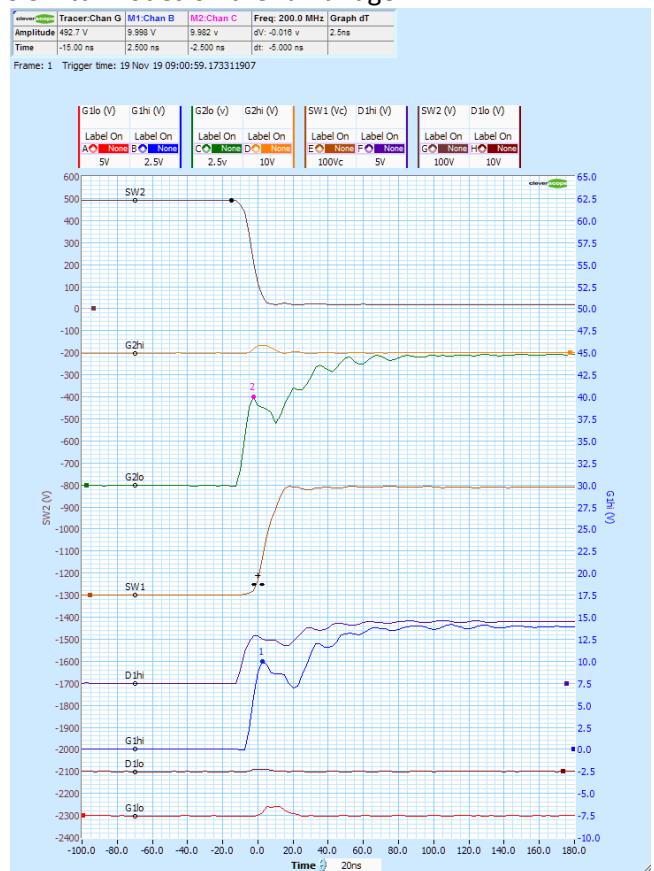
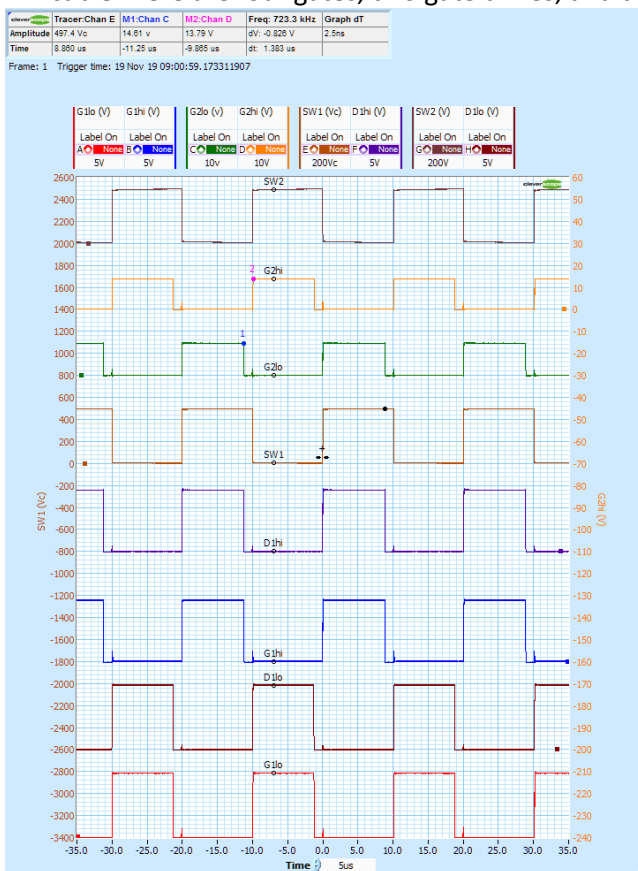

Zoom in on the PDF. Measure the dead time (Marker 1 to Marker 2, 1.383us in this example), the Miller plateau, check for Miller induced droop, Miller induced gate voltage bumps, and use the Maths to measure Gate charge etc.

Measuring Gate Charge in a SEW Movitrac Variable Speed Drive (VSD)

Measuring Gate Drive System

Example: SEW Movitrac

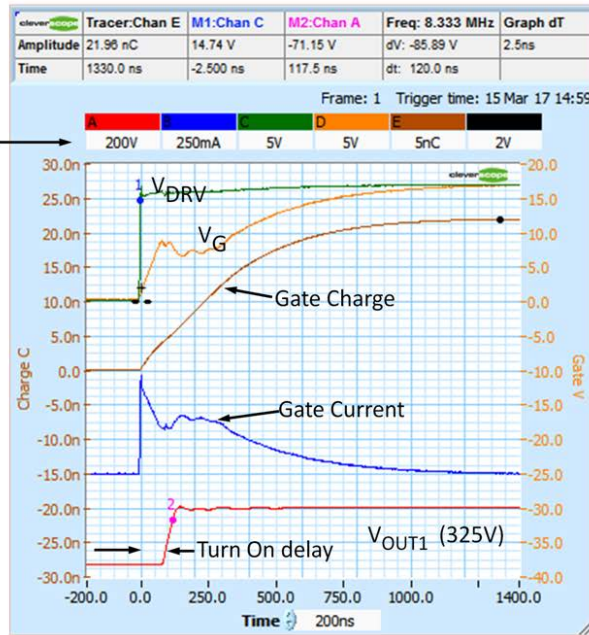
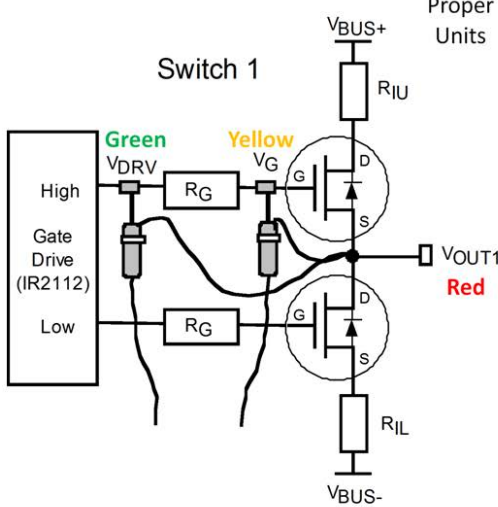

Calculate Charge

$$Qg = \int I_g dt$$

Total Gate Charge

$$Qg = 22nC$$

Calculate Current

$$I_g = \frac{V_G - V_{DRV}}{R_G}$$

Plateau gate current

$$I_g = 400mA$$

The high CMRR, and isolation allow making differential measurements across the gate drive resistor, even though it is swinging 325V in 37ns. Maths is used to calculate the gate current which is then integrated to calculate charge.

Measuring Conduction loss in a SEW Movitrac VSD

We use a Cleverscope V_{CE} Sat probe to accurately measure small voltages while exposed to large (<1000V) voltage swings.

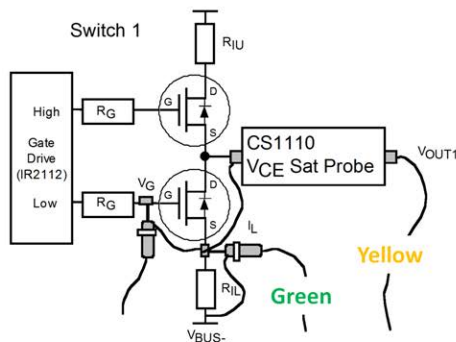

$$E_{sw} = \int P_{sw} dt$$

Use a CS1110 VCE SAT probe to measure conduction peak, and averaged power loss.

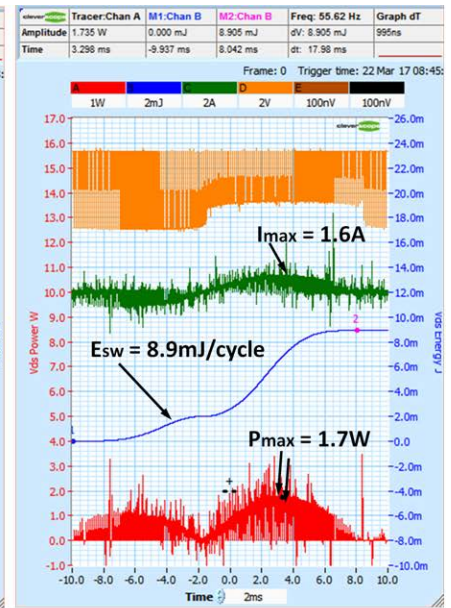
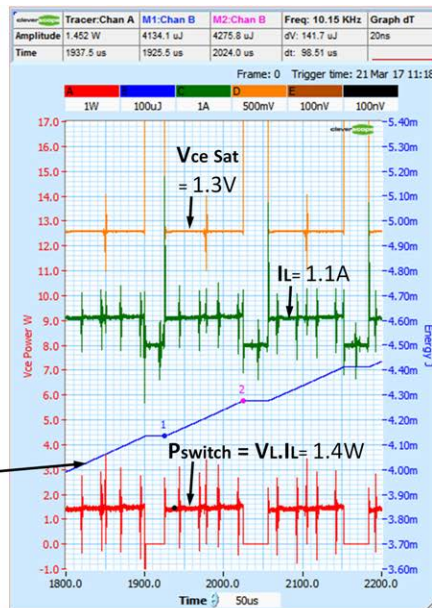

$$E_{sw}/sec = 55 \text{ (Hz)} \times 8.9 = 494 \text{ mJ/s.}$$

$$\text{Average power} = 494mW$$

We use Maths to calculate the conduction current (green), the V_{CE} Sat probe to measure the switch saturation voltage (Yellow), the instantaneous power (red) and the energy per cycle (blue) to calculate the average conduction loss power (494 mW).

Measuring required shielding performance and EMC filtering effectiveness

We use 100x probes to measure the Switch voltage, and the input mains voltage safely.

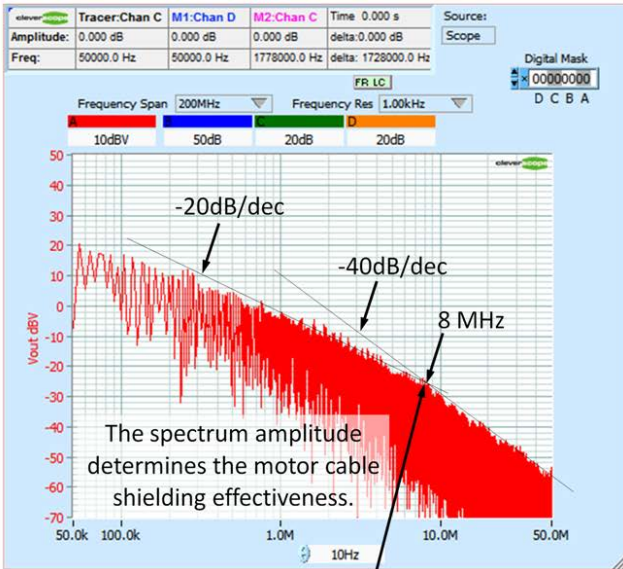

The 20/40 dB/dec corner frequency is set by the rise time ($F = 1/\pi \cdot 37ns$). A slower rise time reduces how good the shield needs to be.

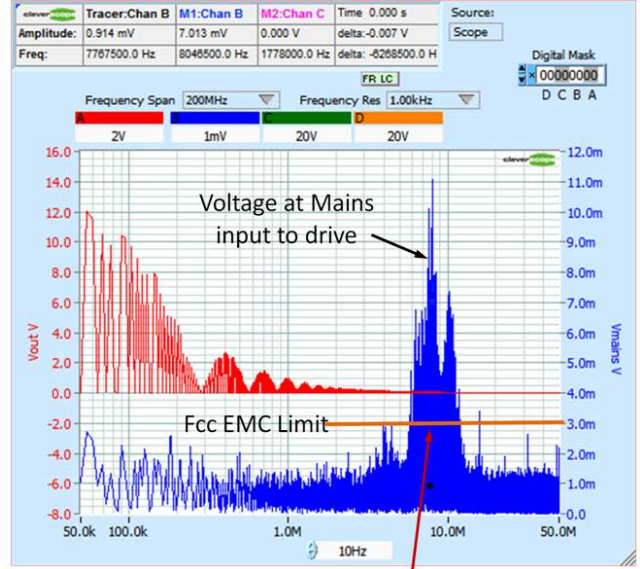

The mains input is not sufficiently filtered, and the drive does not meet the FCC standard. A slower rise time would help, and improved filtering.

This test uses the Spectrum Analyser.

Spectral Noise Floor

This is the full bandwidth noise with all four channels being captured with open inputs, 1kHz resolution, in dBV:

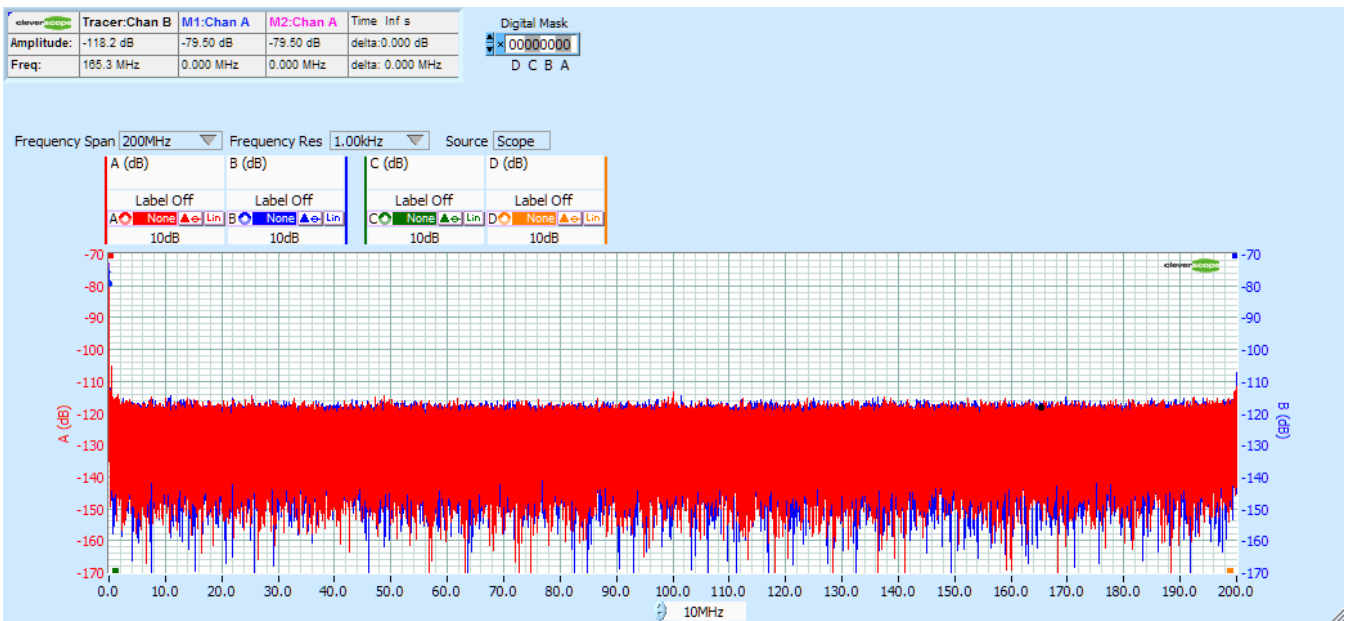

The noise floor is uniform, and below about -115 dBV per bin.

Time Noise Floor

We capture 1M samples, without averaging:

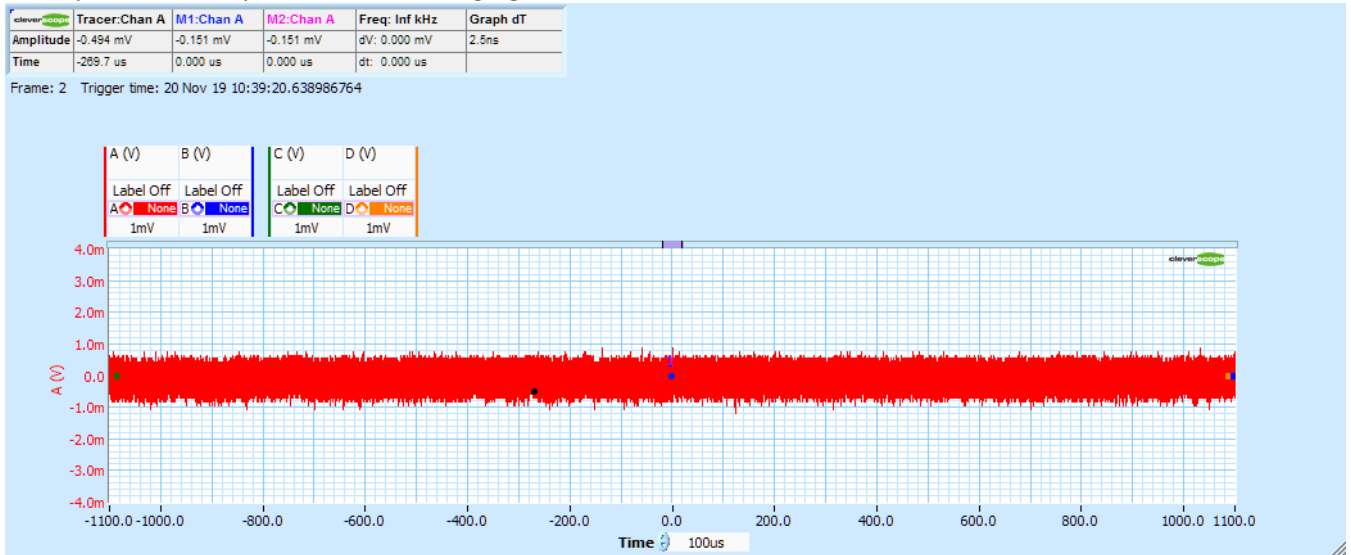

We use the signal information display to calculate the Standard Deviation (a good estimate of RMS, less the DC) and the peak to peak. We see about 200uVrms noise, and less than 1.8mV p-p noise.

The Spectrum Display shows less than 8uV noise per frequency bin (10 kHz) over 200MHz bandwidth, in uV:

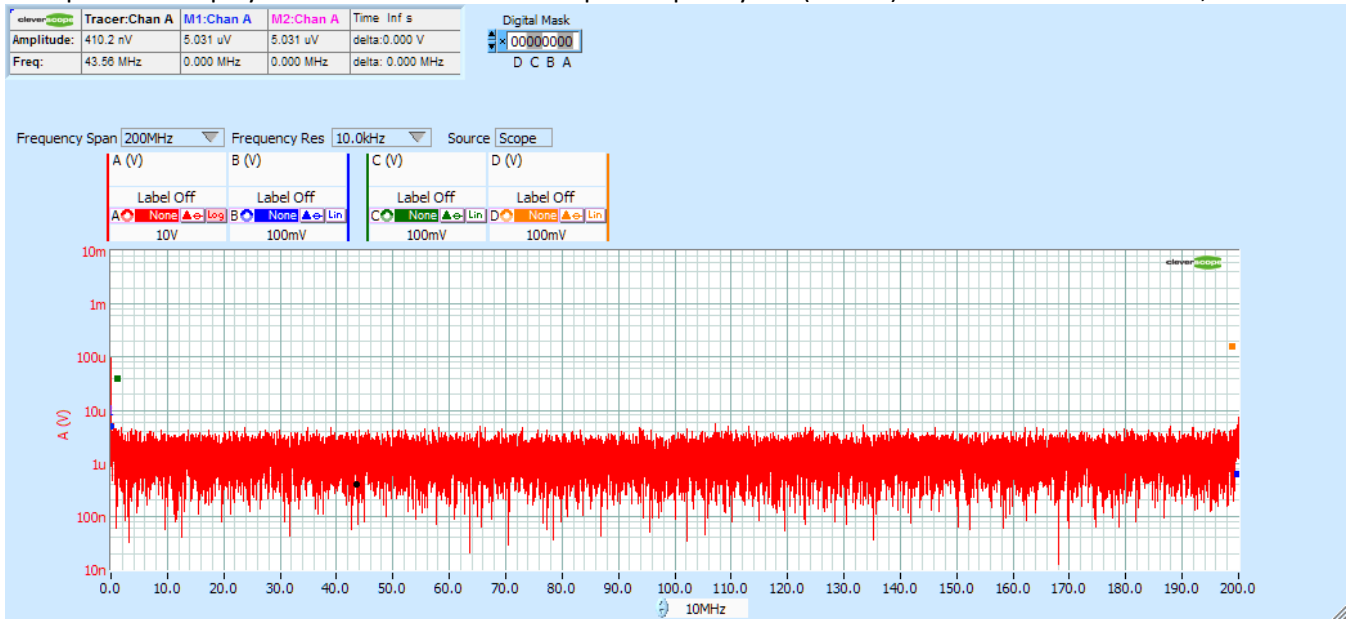

Averaging, and the moving average filter can be used to improve the noise floor to around 200uV p-p :

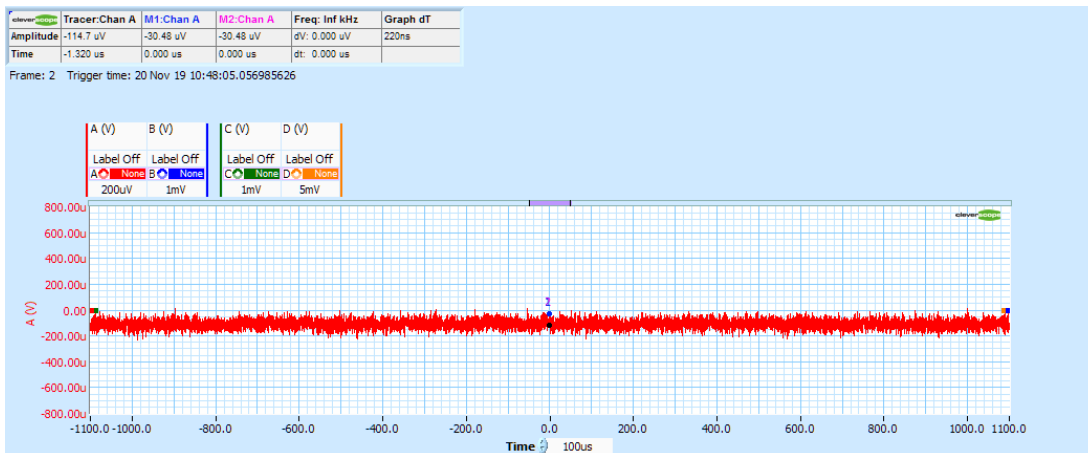

Channel to Channel Skew

Channel to Channel Skew should be low to allow Frequency Response Analysis. Using two channels driven by the same Signal Generator and two length matched coaxial cables, with a 1 MHz signal we measure:

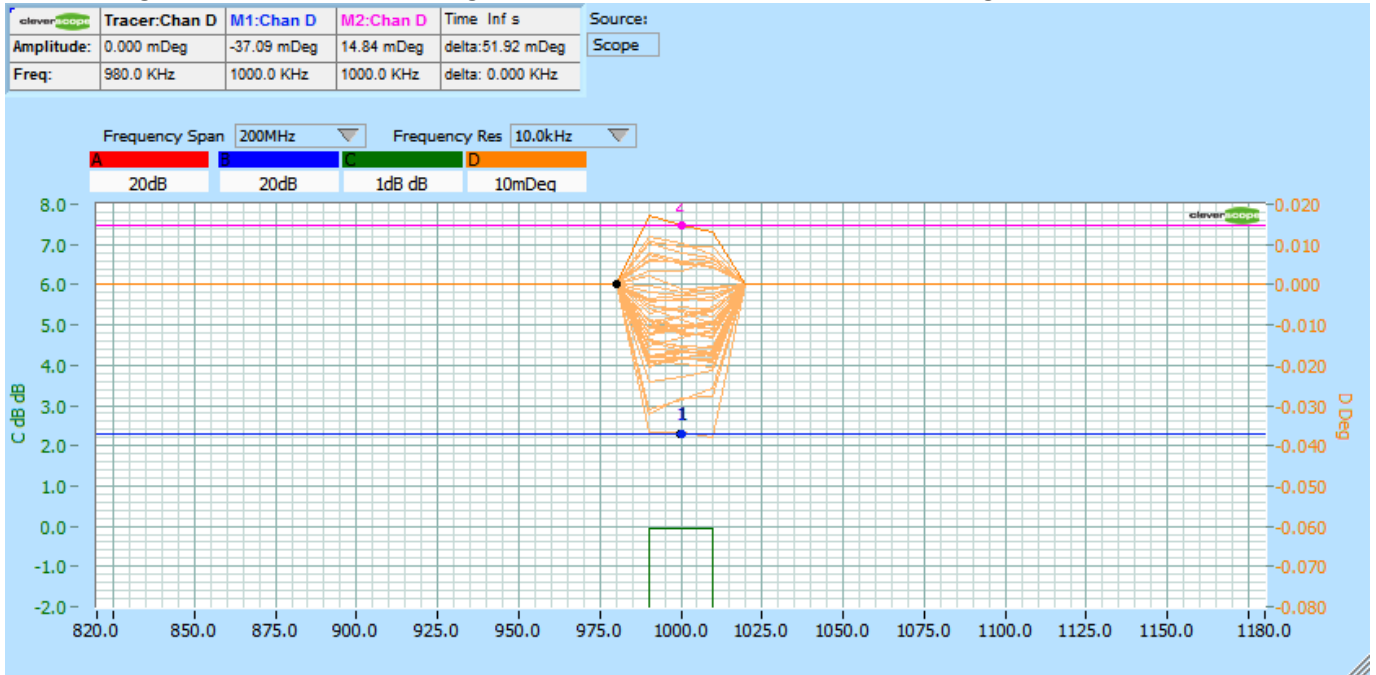

Persistence has been turned on to show the variability. We use Gain/Phase to make the measurement between Chans C and D. Gain was 0 dB. The phase varied from -0.037 deg to +0.015 deg, a variation of 0.052 deg at 1 MHz. This is the same as $0.052/360 \times 1\mu\text{s} = 144\text{ ps p-p}$ variation. This is the same as 1 degree at 19.2 MHz.

Response to 500V 10ns transition

We measure the CS1090 Switch 1 output (500V, 10ns rise time):

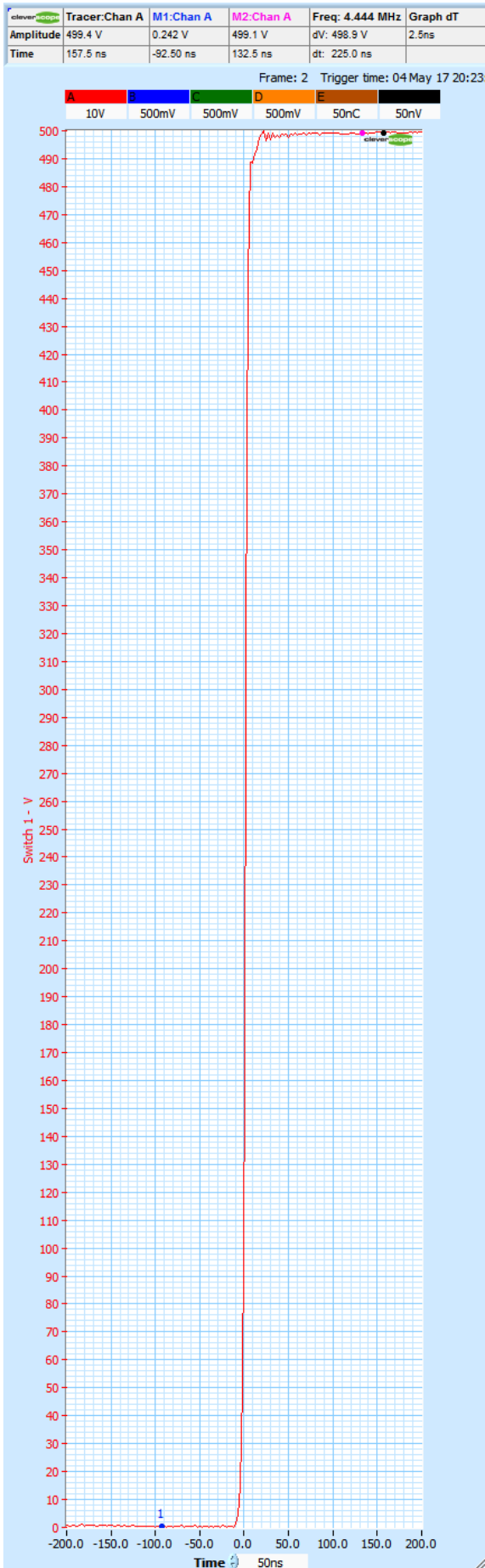

This trace shows the transition measured using a 100x probe. The display pixel resolution masks the actual channel resolution, shown here at 1V/div:

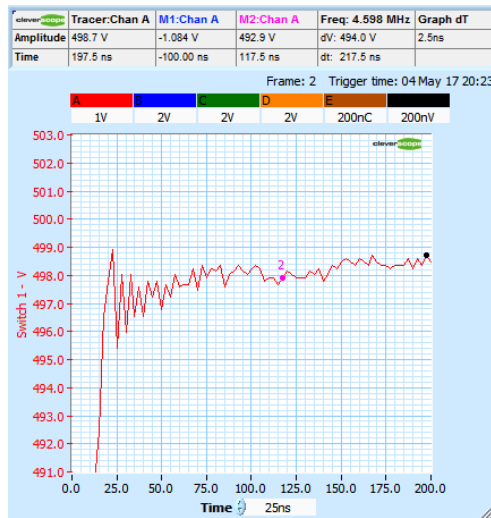

This kind of resolution is not possible with an 8 bit scope.

Frequency Response Analysis Functions (FRA)

The Frequency Response Analysis (FRA) system uses the isolated signal generator to provide stimulus for component, system or power supply measurements. The measurements available are shown in the Displays/FRA section of the data sheet. Here are a collection of measurements made using the FRA system (zoom on the PDF to see the detail):

Impedance of a ceramic capacitor

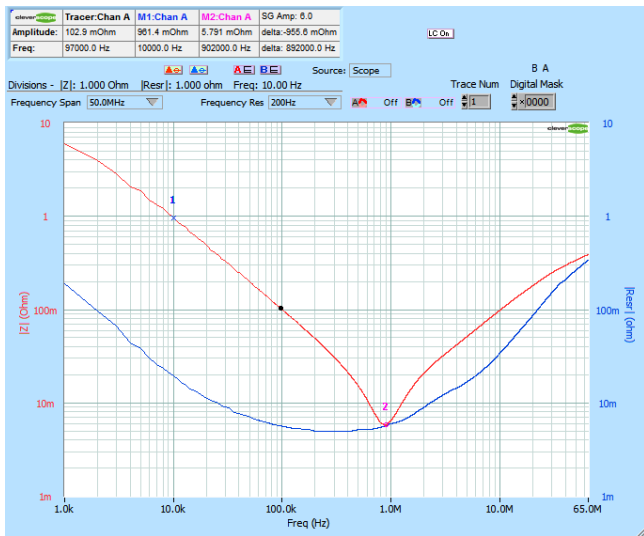

PSU Gain Phase of switching power supply TPS55340 showing Phase Margin (56.8 deg) and Gain Margin (20 dB):

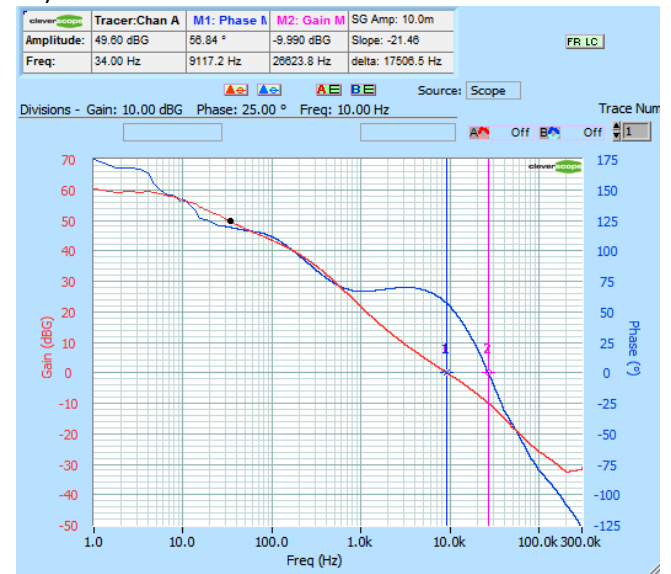

PSU Shunt Impedance and supply ripple TPS55340:

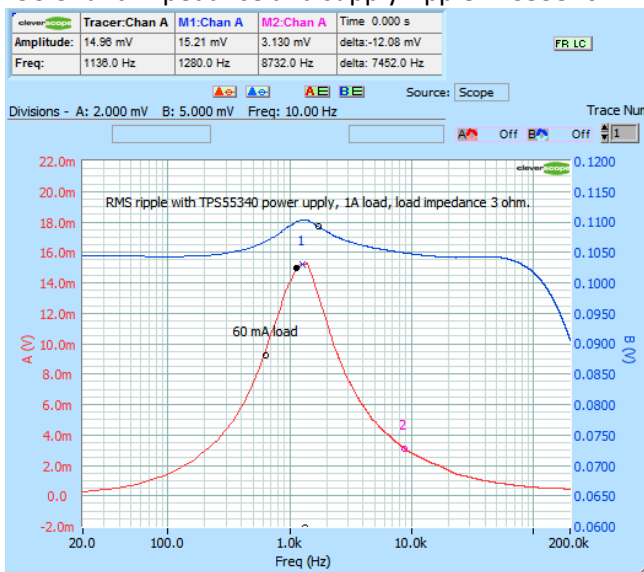

Gain/Phase of a 10.7 MHz filter:

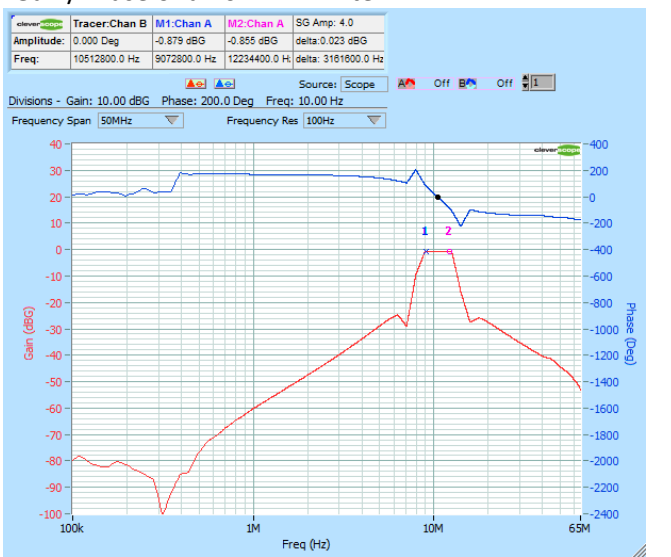

TLV70433 PSRR using CS1070 (1A 50 MHz op-amp):



Powered LTC3589 Output Impedance using CS1070:

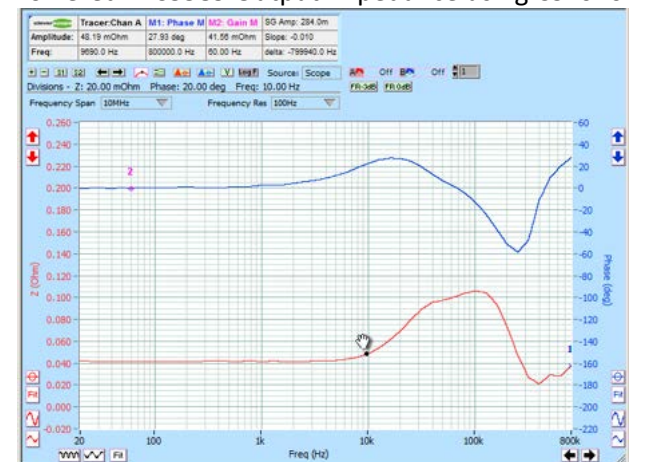

Cleverscope Application Specification

Calibration

Calibration method	Automatic self calibration
Calibration Voltage Source (Internal)	2.5V reference, $\pm 0.15\%$ accuracy, 30 ppm/deg C

Displays

Windows	Simultaneous Capture, Tracking, Spectrum, Information, Maths, XY, Control Panel, Streaming, Frequency Response Analysis (FRA) and Protocol setup windows
Scope window functions	Defines capture specification for signal acquisition unit, defining amount of time before trigger, amount of time after the trigger, lower amplitude limit, upper amplitude limit. Defines Tracking graph time position, when tracking graph is linked. Defines trigger level and direction Full zoom and Pan in both axis. Annotations. Custom units Custom colours
Tracking window functions	Displays zoomed section of captured signal. Resolution from 1ns to 5s/div. Full zoom and Pan in both axis. Annotations. Custom colours
Spectrum window functions	Display spectrum of signal captured in capture window. User definable resolution Full zoom and Pan in both axis. Annotations. Custom units Custom colours
Maths window function	Displays results of Maths equations. Maths equations are user entered expressions involving any of the inputs (analog and digital), previous maths equation line results, and an arbitrary number of function results (+ - * / sqrt, power, log, ln, all transcendental functions, equality functions). Custom units. Provide live Matlab link.
XY window function	Displays XY graph from source (Capture, tracking, spectrum, or Maths
Information window functions	Displays automated measurements (see below) Used to log derived information values to disk, with a period of between 0.05 – 86,400 secs per sample. Live logging to Excel DDE live value transfer to Excel.
Control window functions	Provides Trigger settings – analog and digital Provides Sample control – single, triggered or automatic. Provides access to tools – Pan, Zoom, Annotate Controls Frame store Controls Spectrum resolution, acquisition method and averaging
Frequency Response Analysis (FRA)	FRA control panel is used to setup up oscilloscope/signal generator to make automated measurements of these values vs frequency: <ul style="list-style-type: none"> • RMS Amplitude • Power • Power Density • Gain/Phase • Impedance + R_{ESR} or Q/D Factor or Phase • Capacitance + R_{ESR} or D Factor or Phase • Inductance + R_{ESR} or Q Factor or Phase • Shunt Impedance (magnitude without phase for low impedances) • PSU Gain/Phase - for finding Gain/Phase of powered up power supplies • PSU PSRR - for finding PSRR of powered up power supplies • PSU Output Impedance - for finding Output Impedance of powered up power supplies • PSU Input Impedance - for finding Input Impedance of powered up power supplies • Probe calibration functions for maximum accuracy.
Protocol Setup	Provides protocol setup for I2C, SPI, UART and parallel bus.

Measurements

Cursors	Voltage Difference between cursors Time difference between cursors Reciprocal of ΔT in Hertz ($1/\Delta T$).																																																											
Automated measurements	<table border="1"> <thead> <tr> <th>Function</th> <th>Function</th> <th>Function</th> <th>Function</th> </tr> </thead> <tbody> <tr> <td>DC</td> <td>0 -> 1 Time</td> <td>DC</td> <td>A at F</td> </tr> <tr> <td>RMS</td> <td>1 -> 0 Time</td> <td>RMS</td> <td>B at F</td> </tr> <tr> <td>Max</td> <td>V '1'</td> <td>Fsignal</td> <td>A max</td> </tr> <tr> <td>Min</td> <td>V '0'</td> <td>Vsignal</td> <td>A min</td> </tr> <tr> <td>Pk-Pk</td> <td>V swing</td> <td>F1</td> <td>B max</td> </tr> <tr> <td>Std Dev</td> <td>Overshoot</td> <td>V1</td> <td>B min</td> </tr> <tr> <td>Period</td> <td>Slew rate</td> <td>F2</td> <td>Amax at 0 B</td> </tr> <tr> <td>Fundamental Frequency</td> <td>Pulse Period</td> <td>V2</td> <td>Amin at 0 B</td> </tr> <tr> <td>Fundamental Peak amp</td> <td>Pulse Frequency</td> <td>F3</td> <td>Bmax at 0 A</td> </tr> <tr> <td>Pulse Length</td> <td>Pulse Length</td> <td>V3</td> <td>Bmin at 0 A</td> </tr> <tr> <td>Duty Cycle</td> <td>Duty Cycle</td> <td>SINAD</td> <td>A -3dB L: H</td> </tr> <tr> <td></td> <td></td> <td>THD</td> <td>B -3dB L: H</td> </tr> <tr> <td></td> <td></td> <td>HD2+3</td> <td></td> </tr> </tbody> </table>	Function	Function	Function	Function	DC	0 -> 1 Time	DC	A at F	RMS	1 -> 0 Time	RMS	B at F	Max	V '1'	Fsignal	A max	Min	V '0'	Vsignal	A min	Pk-Pk	V swing	F1	B max	Std Dev	Overshoot	V1	B min	Period	Slew rate	F2	Amax at 0 B	Fundamental Frequency	Pulse Period	V2	Amin at 0 B	Fundamental Peak amp	Pulse Frequency	F3	Bmax at 0 A	Pulse Length	Pulse Length	V3	Bmin at 0 A	Duty Cycle	Duty Cycle	SINAD	A -3dB L: H			THD	B -3dB L: H			HD2+3				
Function	Function	Function	Function																																																									
DC	0 -> 1 Time	DC	A at F																																																									
RMS	1 -> 0 Time	RMS	B at F																																																									
Max	V '1'	Fsignal	A max																																																									
Min	V '0'	Vsignal	A min																																																									
Pk-Pk	V swing	F1	B max																																																									
Std Dev	Overshoot	V1	B min																																																									
Period	Slew rate	F2	Amax at 0 B																																																									
Fundamental Frequency	Pulse Period	V2	Amin at 0 B																																																									
Fundamental Peak amp	Pulse Frequency	F3	Bmax at 0 A																																																									
Pulse Length	Pulse Length	V3	Bmin at 0 A																																																									
Duty Cycle	Duty Cycle	SINAD	A -3dB L: H																																																									
		THD	B -3dB L: H																																																									
		HD2+3																																																										
Custom units	6 characters																																																											
Custom signal names	20 characters																																																											
Custom scaling	Scale + offset by defining two (Vin,Vout) points																																																											
User definable colours	Signals, Background, Major Grid, Minor Grid																																																											

Mathematical Functions

Functions over the signal	Differentiation, Integration, Filtering, Power functions, Matlab interface, Signal Processing functions
Functions on a data point	Addition, subtraction, multiplication, division, squaring, square root, (inverse) sine, cosine, tangent, tangent, log, sign etc. Equality operations.
Maximum number of sequential mathematical equations	10, symbolic with multiple operators and operands.

Spectrum Analysis

Frequency Range	User definable, Range = 0- 1/Scope Graph ΔT Frequency axis – log or linear.
Analysis Output	RMS Amplitude, Power, Power Density, Gain/Phase
Frequency Resolution	In 1, 2, 2.5, 5 sequence with 1 part in 1M resolution.
Output type	Volts, Power, Gain/Phase in linear , dB, degree or radian values. Impedance, LCR, Q and DF. Custom units can be applied.
Window types	None, Hanning, Hamming, Blackman-Harris, Flat top, Low Sidelobe
Averaging	Moving average, block average, peak hold.
Averaging method	Vector averaging in time domain if triggered. RMS averaging in frequency domain if not triggered.

Protocol Decode

Protocols	I2C, SPI , UART and parallel bus.
Protocol decode inputs	Digital Inputs 1-8, External trigger, Channels A, B User defined threshold when using analog inputs
Protocol decode variables	Number of bits, Clock edge rising or falling, Bit invert/non Invert, Select Hi/Lo, MSB first or not, Number of stop bits.
Output display type	Naming label. Character, Hexadecimal or Decimal Number. Colour.

Streaming

Sampling Rate	12 SPS – 3 MSPS (Streaming rate will be improved in the future)
Sample preparation	Peak capture or Filter prior to decimation. Using 10MHz filter with 14 bit ADC we achieve 13 bits ENOB at 3 MSPS (60uV noise floor with +/-0.8V range).
Sample storage	Up to 500 G samples. Samples are stored in multiple smaller files to increase speed.
Review capabilities	Zoom and pan anywhere in sample space. Samples are displayed peak captured (ie 1us pulse will still be visible in 1 day long sample record).
Export capabilities	Export tab delimited text, binary, or cleverscope format file. Output between markers, or current display. Set output depth.

Data Export

File types output	Cleverscope proprietary, Tab delimited text (Excel compatible), Excel file (for signal information logging), binary (format given in help).
Live Data output	DDE to Exel, direct placement of data into live Excel sheet Live data output to and return from Matlab

Windows facilities

Standard Functions	Copy and Paste Save and Open native format (saves full setup) Save and Open tab delimited text file Save and Open binary file (start time, dt, data) Print with Date/Time, File Name and Description. Print Setup
Windows	Dynamically resized Can be placed anywhere on desktop Can be docked to move with Cleverscope Control Panel Can be docked to minimize/restore with one click.
User defined units	6 characters
User defined signal names	20 characters
User defined scaling	Scale + offset by defining two (Vin,Vout) points
User definable colours	Signals, Background, Major Grid, Minor Grid

Document changes:

- 5 May 2017 v1.1 - Original
- 12 July 2018 v1.2 - Added Specification Status section.
- 20 Nov 2019 v1.3 - Added 8 channel display